



PROLYTE

X-H30 Truss

User manual

Part 2: Product-specific instructions

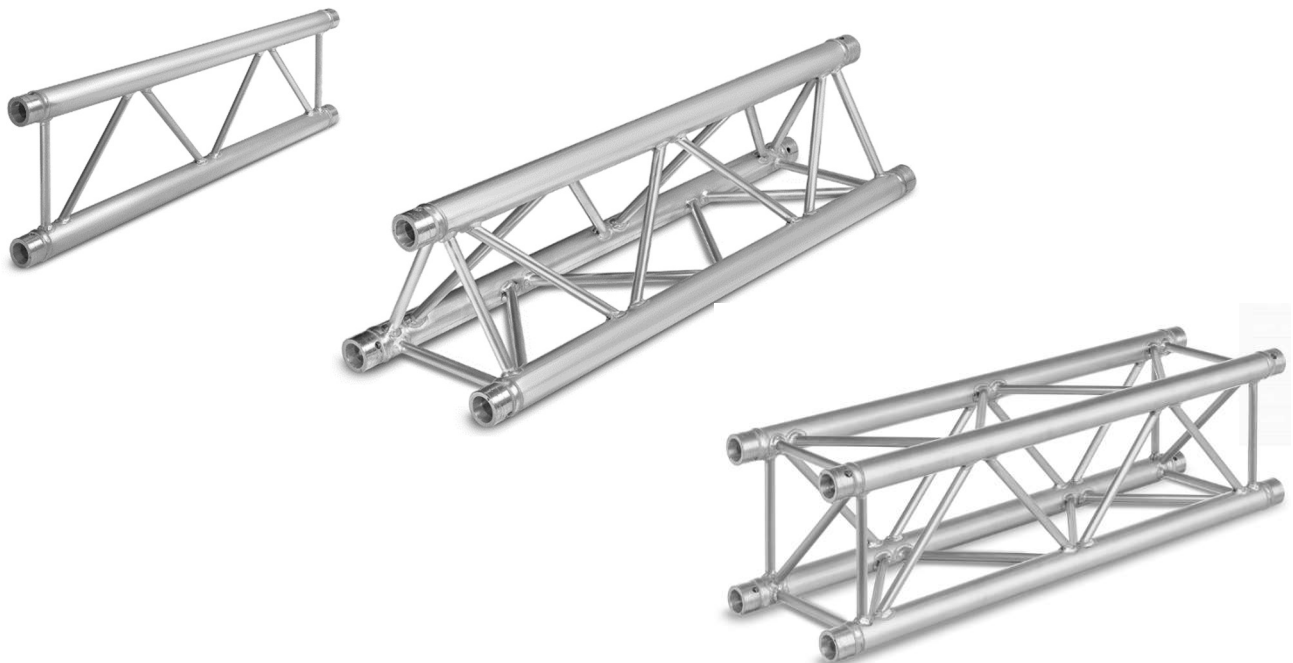

Original instructions

DN00167 Issue 1

July 2023



© 2023 Prolyte BV.

Manufacturer:

Area Four Industries s.r.o.

Spindlerova 286

413 01 Roudnice nad Labem

Czech Republic

T +420 416 810 800

sales@prolyte.com

We have made every effort to ensure the accuracy of this manual. No liability will be accepted for errors. We reserve the right to change or alter our products or manuals without prior notice.

No part of this manual may be reproduced in any form or by any means without prior written permission.

If you have a warranty claim, malfunction or spare part inquiry, contact your point of sale or the manufacturer.

If you have comments or improvement ideas for this document, please contact us by using the e-mail address found on the back cover of the document. All comments and ideas will be carefully considered in the future development of the product or this document.

Contents

1	Introduction	4
1.1	About this product	4
1.2	Related information	4
1.3	About this manual	4
1.4	Terminology.....	5
1.5	Standards.....	5
2	Safety	5
3	Limitations of use.....	5
3.1	Allowable loading	5
3.2	Structural data.....	5
4	Transport, handling and storage	7
5	Identification	7
6	Technical specifications.....	8
6.1	X-series	8
6.2	H-series.....	9
7	Load capacity.....	10
7.1	X-series	10
7.2	H-series.....	12
8	Approved accessories.....	14
9	Coatings and surface treatments	14
10	Slinging methods.....	14
11	Assembly and disassembly.....	14
12	Maintenance	14
13	Inspection.....	14
14	Discard criteria	14
15	Warranty	14
16	Certificates	14

Change history

Issue	Date	Changes
1	July 2023	First issue.

1 Introduction

This manual is intended for truss owners, providers and skilled riggers and any person who has been trained in working safely with trusses.

This manual is Part 2 of the User Manual. The User Manual consists of the following parts:

- Part 1: General instructions
- Part 2: Product-specific instructions

This manual must be read in conjunction with *Part 1: General instructions* of the User Manual.

If there are discrepancies between *Part 1* and *Part 2*, the information given in *Part 2* is the information that applies to the product and overrides the information given in *Part 1*.

This manual assumes that you have been trained or work under the control of a competent or qualified person who has been trained in safety and assembly.

1.1 About this product

PROLYTE trusses are structural elements designed to be repeatedly assembled and disassembled to carry loads in temporary or permanent installations. Depending on the application, PROLYTE trusses can be referred to as lifting accessories or construction products. For information on the related standards, see Chapter 1.5.

The X-SERIES AND H-SERIES series can be used for indoor and outdoor structures.

1.2 Related information

For more information on the product, see www.prolyte.com/products/aluminium-truss

1.3 About this manual

Before working with the product, read this manual carefully and pay attention to the information provided. Use this manual to familiarize yourself with the product, its proper use and safety regulations.

1.3.1 Safety conventions



Indicates a hazardous situation, which, if not avoided, will result in death or serious injury. This signal word is limited to the most extreme situations.



Indicates a hazardous situation, which, if not avoided, could result in death or serious injury.



Indicates a hazardous situation, which, if not avoided, could result in minor or moderate injury.



Indicates information considered important but not hazard-related.

1.4 Terminology

See *PROLYTE Trusses User Manual, Part 1: General instructions*.

Trusses and truss modules are hereinafter referred to by the term “truss”.

1.5 Standards

See *PROLYTE Trusses User Manual, Part 1: General instructions*.

2 Safety

Before working with the product, see the section *Safety* in *Prolyte Trusses User Manual, Part 1: General instructions*. Read the Safety information carefully and pay attention to the information provided.

In addition to the Safety information provided in Part 1, make sure you read the Safety information provided in this product-specific user manual.

NOTICE

Read these safety texts carefully before working with the product.

NOTICE

Make sure manuals are available at all times for all users and employees.

3 Limitations of use

Make sure you read the information provided in section *Limitations of use* in *Prolyte Trusses User Manual, Part 1: General instructions*.

PROLYTE trusses described in this manual are not specifically designed for lifting people. Adequate load reduction and safety precautions, according to local legislation, must be considered when people are lifted.

3.1 Allowable loading

For load capacity information, see Chapter 6.2.

3.2 Structural data

All our trusses are calculated according to the Eurocode 9 (DIN-EN 1999) standard. Eurocodes are standards based on Load and Resistance Factor Design (LRFD).

WARNING

The structural data provided before January 2016 was based on the German DIN 4113 standard. As this standard had a different safety principle, the structural values cannot be compared.

NOTICE

TÜV certificates issued after February 2015 are all based on Eurocode 9.

3.2.1 Regular

Code	Type	Material	Geometry								
			Dimensions centre to centre		Main chord [mm]	diagonals [mm]	Cross-section complete truss				Average dead weight
			Height	Width			A	I _y	I _z	I _T	g
			[mm]	[mm]			[cm ²]	[cm ⁴]	[cm ⁴]	[cm ⁴]	[kg/m]
X30L	Ladder	6082 T6	239	-	51x2	16x2	6.16	763.15	18.51	-	2.5
X30D	Triangular	6082 T6	207	239	51x2	16x2	9.24	771.16	771.01	135	3.8
X30V	Square	6082 T6	239	239	51x2	16x2	12.42	1526.29	1526.29	500	5.1

Table 1: Geometry

Code	Design values of resistances				
	Main chord	Complete truss			
	N _{r,d}	M _{y,r,d}	M _{z,r,d}	V _{z,r,d}	V _{y,r,d}
	[kN]	[kNm]	[kNm]	[kN]	[kN]
X30L	36.45	8.71	-	7.36	-
X30D	36.45	7.55	8.71	12.76	7.36
X30V	36.45	17.42	17.42	14.73	14.73

Table 2: Design values of resistances

3.2.2 Heavy duty

Code	Type	Material	Geometry								
			Dimensions centre to centre		Main chord [mm]	diagonals [mm]	Cross-section complete truss				Average dead weight g [kg/m]
			Height	Width			A	I _y	I _z	I _T	
			[mm]	[mm]			[cm ²]	[cm ⁴]	[cm ⁴]	[cm ⁴]	
H30L	Ladder	6082 T6	239	-	48x3	16x2	8.48	1047.93	21.57	-	3
H30D	Triangular	6082 T6	207	239	48x3	16x2	12.72	1057.29	1057.10	150	5
H30V	Square	6082 T6	239	239	48x3	16x2	16.96	2095.86	2095.86	500	6.3

Table 3: Geometry

Code	Design values of resistances				
	Main chord	Complete truss			
	N _{rd}	M _{y,rd}	M _{z,rd}	V _{z,rd}	V _{y,rd}
	[kN]	[kNm]	[kNm]	[kN]	[kN]
H30L	50.22	12.00	-	7.36	-
H30D	50.22	10.39	12.00	12.76	7.36
H30V	50.22	24.00	24.00	14.73	14.73

Table 4: Design values of resistances

4 Transport, handling and storage

See *PROLYTE Trusses User Manual, Part 1: General instructions*.

5 Identification

See *PROLYTE Trusses User Manual, Part 1: General instructions*.

6 Technical specifications

6.1 X-series

X30L

Top View



Side View

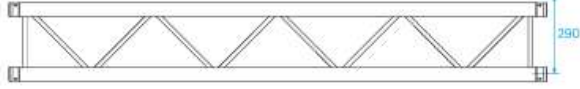

X30D

Top View

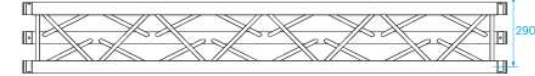

Side View

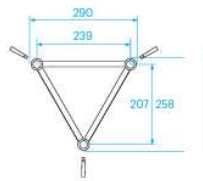
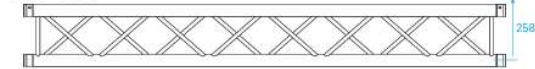

X30V

Top View

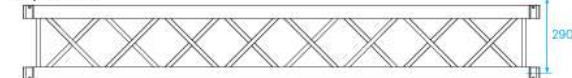

Side View

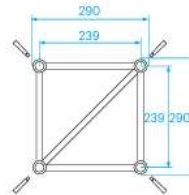
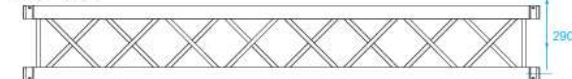

Technical Specifications - X30 Series

Types	Ladder (L), Triangular (D), Square (V)
Alloy	EN AW 6082 T6
Main Chords	51 x 2 mm
Diagonal Members	16 x 2 mm
Coupling System	CCS6

X30 Series - Standard available Lengths and Codes

Metres	Feet	Code*
0.25/1.00 m in 5 mm steps	0.82/3.28', in 0.2' steps	
0,25	0.82	X30-L025
0,29	0.95	X30-L029
0,50	1.64	X30-L050
0,71	2.33	X30-L071
0,75	2.46	X30-L075
1,00	3.28	X30-L100
1,50	4.92	X30-L150
2,00	6.56	X30-L200
2,50	8.20	X30-L250
3,00	9.84	X30-L300
4,00	13.12	X30-L400

*on - indicate L for Ladder, D for Triangular or

6.2 H-series

H30L

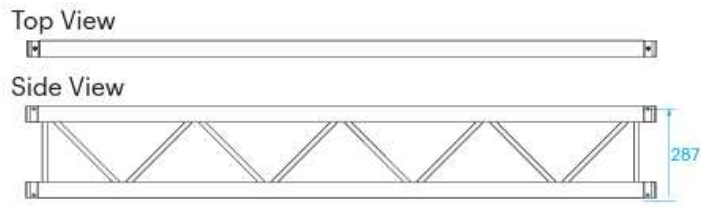

H30D

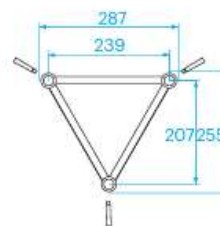
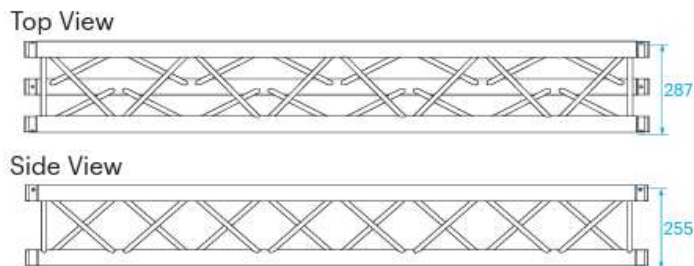

H30V

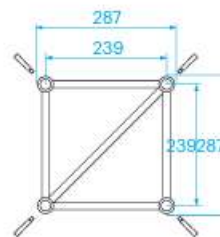
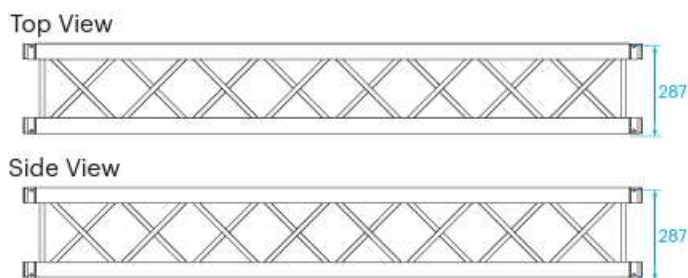

Technical Specifications - H30 Series

Types	Ladder (L), Triangular (D), Square (V)
Alloy	EN AW 6082 T6
Main Chords	48 x 3 mm
Diagonal Members	16 x 2 mm
Coupling System	CCS6

H30 Series - Standard available Lengths and Codes

Metres	Feet	Code*
0,25	0.82	H30--L025
0,29	0.95	H30--L029
0,50	1.64	H30--L050
0,71	2.33	H30--L071
1,00	3.28	H30--L100
1,50	4.92	H30--L150
2,00	6.56	H30--L200
2,50	8.20	H30--L250
3,00	9.84	H30--L300
4,00	13.12	H30--L400

*on - indicate L for Ladder, D for Triangular or

7 Load capacity

In addition to the information and instructions provided in *PROLYTE Trusses User Manual, Part 1: General instructions*, the truss loads shall never exceed the values stated in the load tables below.

7.1 X-series

X30L - Allowable Loading (Span supported on top chord.)

SPAN		Uniformly Distributed Load (UDL)		DEFLECTION		CPL		DEFLECTION	
m	ft	kg/m	lbs/ft	mm	inch	kgs	lbs	mm	inch
1	3,3	979,7	659,2	2	0,1	979,7	2162,2	1	0,0
2	6,6	345,0	232,1	1	0,1	345,0	761,4	1	0,0
3	9,8	135,0	90,8	3	0,1	203,0	448,0	2	0,1
4	13,1	64,0	43,1	4	0,2	128,0	282,5	3	0,1
5	16,4	27,0	18,2	4	0,2	67,0	147,9	3	0,1
6	19,7	12,0	8,1	4	0,1	36,0	79,5	3	0,1

1 inch = 25,4 mm | 1m = 3.28 ft | 1 lbs = 0,453 kg

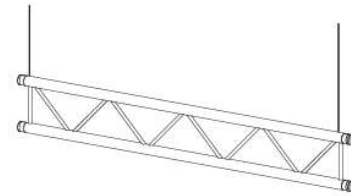

Spans must be supported at each end.
Loads must be suspended from bottom chord only.

X30L - Allowable Loading (Top chord sideways supported each metre.)

SPAN		Uniformly Distributed Load (UDL)		DEFLECTION		CPL		DEFLECTION	
m	ft	kg/m	lbs/ft	mm	inch	kgs	lbs	mm	inch
4	13,1	243,2	163,7	18	0,7	459,8	1014,8	15	0,6
5	16,4	176,3	118,6	28	1,1	381,7	842,3	23	0,9
6	19,7	123,2	82,9	41	1,6	325,5	718,3	33	1,3
7	23,0	90,6	61,0	55	2,2	283,0	624,7	44	1,7
8	26,2	69,2	46,6	72	2,9	249,8	551,2	58	2,3
9	29,5	54,4	36,6	92	3,6	222,9	492,0	73	2,9
10	32,8	43,7	29,4	113	4,5	200,7	443,0	91	3,6
11	36,1	35,8	24,1	137	5,4	182,1	401,8	110	4,3
12	39,4	29,8	20,0	163	6,4	166,1	366,5	131	5,1

1 inch = 25,4 mm | 1m = 3.28 ft | 1 lbs = 0,453 kg

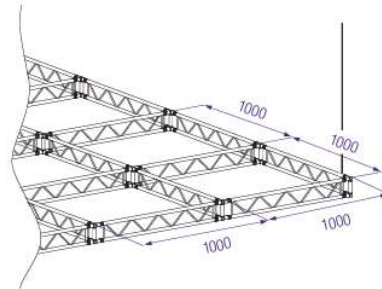

Spans must be supported at each end.
Loads must be suspended from bottom chord only.

X30L - Allowable Loading (Top chords sideways supported every 2 metres.)

SPAN		Uniformly Distributed Load (UDL)		DEFLECTION		CPL		DEFLECTION	
m	ft	kg/m	lbs/ft	mm	inch	kgs	lbs	mm	inch
4	13,1	84,6	56,9	5	0,2	169,1	373,3	4	0,2
5	16,4	53,3	35,9	8	0,3	133,3	294,1	7	0,3
6	19,7	36,3	24,4	12	0,5	109,0	240,6	10	0,4
7	23,0	26,1	17,6	17	0,7	91,3	201,6	13	0,5
8	26,2	19,5	13,1	22	0,9	77,8	171,7	17	0,7
9	29,5	14,9	10,0	27	1,1	67,0	148,0	22	0,9
10	32,8	11,6	7,8	34	1,3	58,2	128,4	27	1,1
11	36,1	9,2	6,2	41	1,6	50,8	112,0	33	1,3
12	39,4	7,4	5,0	49	1,9	44,4	97,9	39	1,5

1 inch = 25,4 mm | 1m = 3.28 ft | 1 lbs = 0,453 kg

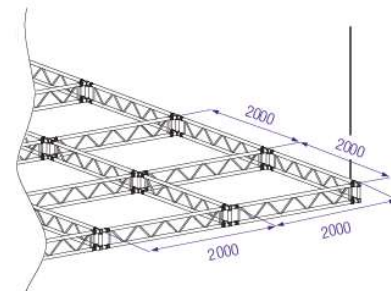

Spans must be supported at each end.
Loads must be suspended from bottom chord only.

X30D - Allowable Loading



SPAN		Uniformly Distributed Load		DEFLECTION		MAXIMUM ALLOWABLE POINT LOADS										SPAN
						Centre Point Load		DEFLECTION		Single Load Third Points Load per Point		Single Load Fourth Points Load per Point		Single Load Fifth Points Load per Point		
m	ft	kg/m	lbs/ft	mm	inch	kgs	lbs	mm	inch	kgs	lbs	kgs	lbs	kgs	lbs	total weight
3	9,8	443,7	298,6	13	0,5	576,3	1272,0	10	0,4	405,2	894,3	308,9	681,7	245,6	542,1	11,4
4	13,1	248,1	166,9	23	0,9	444,8	981,8	19	0,7	317,5	700,6	234,6	517,7	188,6	416,3	15,2
5	16,4	157,6	106,0	36	1,4	360,8	796,3	29	1,1	260,1	574,1	188,3	415,6	152,5	336,6	19,0
6	19,7	108,4	72,9	52	2,1	302,2	667,0	42	1,7	219,5	484,5	156,6	345,7	127,5	281,4	22,8
7	23,0	78,7	53,0	71	2,8	258,9	571,4	57	2,2	189,2	417,6	133,5	294,6	109,1	240,7	26,6
8	26,2	59,5	40,0	93	3,7	225,4	497,4	75	2,9	165,6	365,4	115,7	255,4	94,9	209,4	30,4
9	29,5	46,3	31,1	118	4,6	198,6	438,2	94	3,7	146,6	323,5	101,6	224,3	83,6	184,4	34,2
10	32,8	36,8	24,8	146	5,7	176,6	389,7	117	4,6	130,9	289,0	90,1	198,9	74,3	163,9	38,0
11	36,1	29,8	20,1	176	6,9	158,1	348,9	141	5,6	117,7	259,9	80,5	177,7	66,5	146,8	41,8
12	39,4	24,5	16,5	210	8,3	142,3	314,0	168	6,6	106,4	234,9	72,3	159,7	59,9	132,1	45,6
13	42,6	20,4	13,7	246	9,7	128,6	283,8	197	7,8	96,6	213,2	65,3	144,1	54,1	119,5	49,4
14	45,9	17,1	11,5	285	11,2	116,5	257,2	228	9,0	87,9	194,1	59,1	130,4	49,1	108,3	53,2
15	49,2	14,5	9,7	328	12,9	105,8	233,6	262	10,3	80,2	177,1	53,6	118,2	44,6	98,4	57,0
16	52,5	12,3	8,3	373	14,7	96,2	212,3	298	11,7	73,3	161,7	48,6	107,4	40,6	89,6	60,8

1 inch = 25,4 mm | 1m = 3.28 ft | 1 lbs = 0,453 kg

X30V - Allowable Loading



SPAN		Uniformly Distributed Load		DEFLECTION		MAXIMUM ALLOWABLE POINT LOADS										SPAN
						Centre Point Load		DEFLECTION		Single Load Third Points Load per Point		Single Load Fourth Points Load per Point		Single Load Fifth Points Load per Point		
m	ft	kg/m	lbs/ft	mm	inch	kgs	lbs	mm	inch	kgs	lbs	kgs	lbs	kgs	lbs	total weight
3	9,8	650,0	437,4	10	0,4	1215,0	2681,5	8	0,3	853,5	1883,6	650,0	1434,6	487,5	1076,0	15,3
4	13,1	486,4	327,3	18	0,7	959,5	2117,5	15	0,6	664,0	1465,5	523,6	1155,5	411,2	907,5	20,4
5	16,4	367,1	247,0	28	1,1	791,1	1746,0	23	0,9	555,2	1225,4	424,9	937,7	337,3	744,5	25,5
6	19,7	253,5	170,6	41	1,6	671,5	1482,0	33	1,3	476,1	1050,8	356,6	787,1	285,4	629,8	30,6
7	23,0	185,1	124,5	55	2,2	581,9	1284,3	44	1,7	415,9	918,0	306,5	676,5	246,7	544,4	35,7
8	26,2	140,6	94,6	72	2,9	512,2	1130,4	58	2,3	368,5	813,2	268,1	591,6	216,7	478,3	40,8
9	29,5	110,1	74,1	92	3,6	456,2	1006,8	73	2,9	330,0	728,3	237,5	524,2	192,7	425,4	45,9
10	32,8	88,3	59,4	113	4,5	410,1	905,1	91	3,6	298,1	658,0	212,7	469,3	173,1	382,0	51,0
11	36,1	72,2	48,6	137	5,4	371,4	819,7	110	4,3	271,2	598,6	191,9	423,6	156,6	345,7	56,1
12	39,4	59,9	40,3	163	6,4	338,4	746,9	131	5,1	248,1	547,6	174,4	384,8	142,7	314,8	61,2
13	42,6	50,4	33,9	191	7,5	309,9	683,9	153	6,0	228,1	503,4	159,2	351,4	130,6	288,2	66,3
14	45,9	42,8	28,8	222	8,7	284,9	628,7	178	7,0	210,5	464,5	146,1	322,4	120,0	264,8	71,4
15	49,2	36,7	24,7	255	10,0	262,7	579,8	204	8,0	194,8	429,9	134,4	296,7	110,7	244,2	76,5
16	52,5	31,7	21,3	290	11,4	242,9	536,1	232	9,1	180,8	399,0	124,1	273,9	102,3	225,9	81,6
17	55,8	27,6	18,5	327	12,9	225,1	496,8	262	10,3	168,1	371,0	114,8	253,4	94,8	209,3	86,7
18	59,0	24,1	16,2	367	14,4	208,9	461,1	294	11,6	156,6	345,6	106,4	234,8	88,0	194,3	91,8
19	62,3	21,2	14,2	409	16,1	194,1	428,5	327	12,9	146,0	322,3	98,7	217,9	81,8	180,6	96,9
20	65,6	18,6	12,5	453	17,8	180,5	398,5	363	14,3	136,3	300,8	91,7	202,4	76,1	168,1	102

1 inch = 25,4 mm | 1m = 3.28 ft | 1 lbs = 0,453 kg

- Tüv certification only valid for loading table above.
- Loading figures are only valid for static loads.
- Loading figures are only valid for single spans with supports at both ends.
- All static systems, other than single spans, need an individual structural calculation. Please contact a structural engineer or Prolyte for assistance.
- Loading figures are calculated according to and in full compliance with European standards (Eurocode).
- The self-weight of the trusses is already taken into account.
- Loading figures are only valid for the cross sectional orientation of the truss as shown by the icon in the loading table.
- The interaction between bending moment and shear force at the connection point is already taken into account.
- Truss spans can be assembled from different truss lengths.

7.2 H-series

H30L - Allowable Loading (Span supported on top chord.)

SPAN		UDL		DEFLECTION		CPL		DEFLECTION	
m	ft	kg/m	lbs/ft	mm	inch	kgs	lbs	mm	inch
1	3,3	979,2	658,9	1	0,0	979,2	2161,2	1	0,0
2	6,6	389,0	261,7	1	0,0	389,0	858,5	1	0,0
3	9,8	156,0	105,0	2	0,1	234,0	516,4	2	0,1
4	13,1	73,0	49,1	3	0,1	146,0	322,2	3	0,1
5	16,4	36,0	24,2	4	0,2	90,0	198,6	3	0,1
6	19,7	15,0	10,1	3	0,1	45,0	99,3	3	0,1

1 inch = 25,4 mm | 1m = 3.28 ft | 1 lbs = 0,453 kg

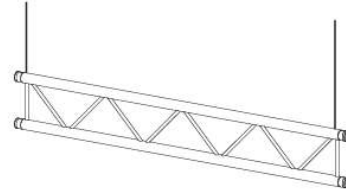

Spans must be supported at each end.
Loads must be suspended from bottom chord only.

H30L - Allowable Loading (Top chord sideways supported each meter.)

SPAN		UDL		DEFLECTION		CPL		DEFLECTION	
m	ft	kg/m	lbs/ft	mm	inch	kgs	lbs	mm	inch
4	13,1	242,8	163,4	18	0,7	619,9	1368,1	15	0,6
5	16,4	193,7	130,3	28	1,1	516,7	1140,5	23	0,9
6	19,7	161,0	108,3	41	1,6	442,2	975,9	33	1,3
7	23,0	124,6	83,9	56	2,2	385,6	851,0	45	1,8
8	26,2	95,4	64,2	73	2,9	341,1	752,9	58	2,3
9	29,5	75,1	50,5	92	3,6	305,2	673,6	74	2,9
10	32,8	60,5	40,7	114	4,5	275,5	608,0	91	3,6
11	36,1	49,6	33,4	137	5,4	250,4	552,7	110	4,3
12	39,4	41,4	27,8	164	6,4	229,0	505,3	131	5,2

1 inch = 25,4 mm | 1m = 3.28 ft | 1 lbs = 0,453 kg

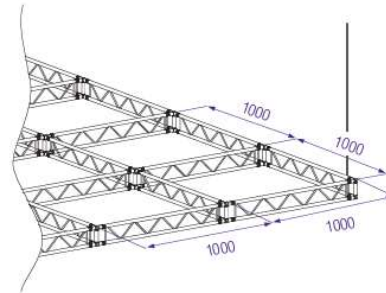

Spans must be supported at each end.
Loads must be suspended from bottom chord only.

H30L - Allowable Loading (Top chords sideways supported every 2 meters.)

SPAN		UDL		DEFLECTION		CPL		DEFLECTION	
m	ft	kg/m	lbs/ft	mm	inch	kgs	lbs	mm	inch
4	13,1	95,2	64,1	4	0,2	190,5	420,3	4	0,1
5	16,4	60,0	40,4	7	0,3	149,9	330,9	6	0,2
6	19,7	40,8	27,5	10	0,4	122,5	270,3	8	0,3
7	23,0	29,3	19,7	14	0,5	102,5	226,1	11	0,4
8	26,2	21,8	14,7	18	0,7	87,1	192,3	14	0,6
9	29,5	16,6	11,2	23	0,9	74,9	165,3	18	0,7
10	32,8	13,0	8,7	28	1,1	64,8	143,1	22	0,9
11	36,1	10,2	6,9	34	1,3	56,4	124,4	27	1,1
12	39,4	8,2	5,5	40	1,6	49,1	108,3	32	1,3

1 inch = 25,4 mm | 1m = 3.28 ft | 1 lbs = 0,453 kg

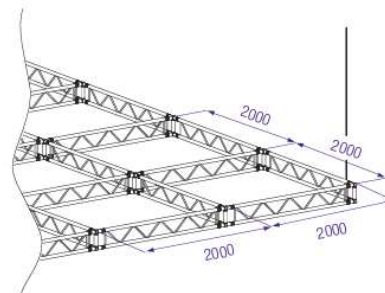

Spans must be supported at each end.
Loads must be suspended from bottom chord only.

H30D - Allowable Loading

SPAN		Uniformly Distributed Load		DEFLECTION		CPL		DEFLECTION		TPL		QPL		FPL		SPAN
		kg/m	lbs/ft			kgs	lbs			kgs	lbs	kgs	lbs	kgs	lbs	
m	ft	kg/m	lbs/ft	mm	inch	kgs	lbs	mm	inch	kgs	lbs	kgs	lbs	kgs	lbs	total weight
3	9,8	562,4	378,4	13	0,5	782,3	1726,6	11	0,4	546,6	1206,4	422,2	931,8	334,1	737,4	15,0
4	13,1	342,0	230,1	23	0,9	606,0	1337,5	19	0,7	430,3	949,7	321,3	709,2	257,4	568,1	20,0
5	16,4	217,3	146,2	37	1,5	492,8	1087,6	29	1,2	353,7	780,6	258,4	570,2	208,6	460,4	25,0
6	19,7	149,5	100,6	53	2,1	413,6	912,8	42	1,7	299,3	660,5	215,2	474,9	174,7	385,5	30,0
7	23,0	108,6	73,1	72	2,8	354,9	783,2	57	2,3	258,4	570,4	183,6	405,1	149,6	330,3	35,0
8	26,2	82,1	55,3	94	3,7	309,4	682,8	75	3,0	226,6	500,0	159,3	351,6	130,3	287,7	40,0
9	29,5	63,9	43,0	118	4,6	273,0	602,4	95	3,7	200,9	443,4	140,1	309,2	114,9	253,6	45,0
10	32,8	50,9	34,3	146	5,7	243,1	536,4	117	4,6	179,7	396,6	124,4	274,5	102,3	225,8	50,0
11	36,1	41,3	27,8	177	7,0	217,9	481,0	142	5,6	161,8	357,2	111,2	245,5	91,7	202,4	55,0
12	39,4	34,0	22,9	211	8,3	196,5	433,6	169	6,6	146,5	323,4	100,1	220,9	82,7	182,5	60,0
13	42,6	28,3	19,0	247	9,7	177,8	392,5	198	7,8	133,2	294,0	90,4	199,6	74,9	165,2	65,0
14	45,9	23,8	16,0	287	11,3	161,4	356,3	229	9,0	121,5	268,1	82,0	180,9	68,0	150,1	70,0
15	49,2	20,1	13,6	329	13,0	146,9	324,1	263	10,4	111,0	245,0	74,5	164,3	61,9	136,6	75,0
16	52,5	17,2	11,5	375	14,8	133,8	295,3	300	11,8	101,6	224,2	67,7	149,5	56,4	124,5	80,0

1 inch = 25,4 mm | 1m = 3.28 ft | 1 lbs = 0,453 kg

H30V - Allowable Loading

SPAN		Uniformly Distributed Load		DEFLECTION		CPL		DEFLECTION		TPL		QPL		FPL		SPAN
		kg/m	lbs/ft			kgs	lbs			kgs	lbs	kgs	lbs	kgs	lbs	
m	ft	kg/m	lbs/ft	mm	inch	kgs	lbs	mm	inch	kgs	lbs	kgs	lbs	kgs	lbs	total weight
3	9,8	649,0	436,7	10	0,4	1667,9	3681,0	8	0,3	973,4	2148,4	649,0	1432,2	486,7	1074,2	18,9
4	13,1	485,3	326,5	18	0,7	1298,1	2864,9	15	0,6	932,1	2057,2	647,1	1428,1	485,3	1071,1	25,2
5	16,4	387,1	260,5	28	1,1	1074,2	2370,9	23	0,9	749,1	1653,3	581,1	1282,5	469,0	1035,1	31,5
6	19,7	321,6	216,4	41	1,6	914,4	2018,2	33	1,3	644,7	1422,8	488,7	1078,6	389,3	859,3	37,8
7	23,0	255,6	172,0	56	2,2	794,4	1753,2	45	1,8	564,8	1246,5	420,7	928,6	337,3	744,4	44,1
8	26,2	194,4	130,8	73	2,9	700,6	1546,3	58	2,3	501,6	1107,0	368,5	813,3	296,9	655,2	50,4
9	29,5	152,4	102,5	92	3,6	625,2	1379,9	74	2,9	450,2	993,7	327,0	721,8	264,5	583,8	56,7
10	32,8	122,3	82,3	114	4,5	563,2	1242,9	91	3,6	407,6	899,5	293,2	647,1	238,0	525,2	63,0
11	36,1	100,1	67,4	137	5,4	511,0	1127,8	110	4,3	371,5	820,0	265,1	585,0	215,7	476,1	69,3
12	39,4	83,2	56,0	164	6,5	466,5	1029,6	131	5,2	340,6	751,7	241,2	532,3	196,8	434,3	75,6
13	42,6	70,1	47,2	192	7,6	428,0	944,6	154	6,1	313,7	692,4	220,7	487,0	180,5	398,3	81,9
14	45,9	59,6	40,1	223	8,8	394,3	870,2	178	7,0	290,1	640,2	202,8	447,5	166,2	366,8	88,2
15	49,2	51,2	34,5	256	10,1	364,5	804,3	205	8,1	269,1	593,8	187,0	412,8	153,6	338,9	94,5
16	52,5	44,3	29,8	291	11,5	337,8	745,5	233	9,2	250,3	552,3	173,0	381,9	142,3	314,1	100,8
17	55,8	38,6	26,0	328	12,9	313,8	692,5	263	10,4	233,3	514,9	160,4	354,1	132,2	291,8	107,1
18	59,0	33,8	22,8	368	14,5	292,0	644,5	295	11,6	217,9	480,8	149,1	329,0	123,1	271,6	113,4
19	62,3	29,8	20,0	410	16,1	272,2	600,7	328	12,9	203,7	449,6	138,7	306,2	114,7	253,2	119,7
20	65,6	26,3	17,7	454	17,9	253,9	560,4	364	14,3	190,7	420,9	129,3	285,3	107,1	236,3	126

1 inch = 25,4 mm | 1m = 3.28 ft | 1 lbs = 0,453 kg

- Tuv certification only valid for loading table above.
- Loading figures are only valid for static loads.
- Loading figures are only valid for single spans with supports at both ends.
- All static systems, other than single spans, need an individual structural calculation. Please contact a structural engineer or Prolyte for assistance.
- Loading figures are calculated according to and in full compliance with European standards (Eurocode).
- The self-weight of the trusses is already taken into account.
- Loading figures are only valid for the cross sectional orientation of the truss as shown by the icon in the loading table.
- The interaction between bending moment and shear force at the connection point is already taken into account.
- Truss spans can be assembled from different truss lengths.
- Read the manual before assembling, using and loading the truss.

8 Approved accessories

For a complete overview of approved accessories, see our brochures or www.prolyte.com.

WARNING

By using excessive force when tightening accessories such as lamp hooks or cell clamps, you may cause damage to the truss chords.

CAUTION

Pay special attention when using lamp hooks or cell clamps. Their inside radius may not meet the tube they need to be attached to. This can lead to severe damage.

NOTICE

You should never allow accessories to damage other products.

9 Coatings and surface treatments

See *PROLYTE Trusses User Manual, Part 1: General instructions*.

10 Slinging methods

See *PROLYTE Trusses User Manual, Part 1: General instructions*.

11 Assembly and disassembly

See *PROLYTE Trusses User Manual, Part 1: General instructions*.

12 Maintenance

See *PROLYTE Trusses User Manual, Part 1: General instructions*.

13 Inspection

See *PROLYTE Trusses User Manual, Part 1: General instructions*.

14 Discard criteria

See *PROLYTE Trusses User Manual, Part 1: General instructions*.

15 Warranty

See *PROLYTE Trusses User Manual, Part 1: General instructions*.

16 Certificates

The TÜV certificates for this product are available at:

www.prolyte.com/support/certificates/certificates-download

Contact details:

PROLYTE BV.

Industriepark 9

9351PA Leek

The Netherlands

T +31 594 85 15 15

sales@prolyte.com



www.prolyte.com